

User Manual

Pure Sine Wave Inverter & Charger

8000W/10000W/12000W



Table Of Contents

| | |
|--|-----------|
| SAFETY INSTRUCTIONS | 1 |
| INTRODUCTION | 2 |
| 1.Basic System Architecture | 2 |
| 2.Product Features..... | 3 |
| PRODUCT OVERVIEW | 4 |
| 1.Top view | 4 |
| 2.Real view..... | 4 |
| OPERATION AND DISPLAY PANEL | 5 |
| LED Indicator | 5 |
| LCD Display Icons | 6 |
| LCD Setting | 8 |
| Fault Reference Code | 13 |
| SPECIFICATIONS | 14 |
| Appendix | 15 |

SAFETY INSTRUCTIONS



WARNING: This chapter contains important safety and operating instructions.

Read and keep this manual for future reference.

1. Before using the unit, read **all** instructions and cautionary markings on the unit, the batteries and **all** appropriate sections of this manual.
2. **CAUTION** –To reduce risk of injury, charge only deep-cycle lead acid type rechargeable batteries. Other types of batteries may burst, causing personal injury and damage.
3. Do not disassemble the unit. Take it to a qualified service center when service or repair is required. Incorrect re-assembly may result in a risk of electric shock or fire.
4. To reduce risk of electric shock, disconnect **all** wirings before attempting any maintenance or cleaning. Turning off the unit **will not** reduce this risk.
5. **CAUTION** – Only qualified personnel can install this device with battery.
6. **NEVER** charge a frozen battery.
7. For optimum operation of this inverter/charger, please follow required spec to select appropriate cable size. It's very important to correctly operate this inverter/charger.
8. Be very cautious when working with metal tools on or around batteries. A potential risk exists to drop a tool to spark or short circuit batteries or other electrical parts and could cause an explosion.
9. Please strictly follow installation procedure when you want to disconnect AC or DC terminals. Please refer to **INSTALLATION** section of this manual for the details.
10. **GROUNDING INSTRUCTIONS** -This inverter/charger should be connected to a permanent grounded wiring system. Be sure to comply with local requirements and regulation to install this inverter.
11. **NEVER** cause AC output and DC input short circuited. Do **NOT** connect to the mains when DC input short circuits.
12. **Warning!!** Only qualified service persons are able to service this device. If errors still persist after following troubleshooting table, please send this inverter/charger back to local dealer or service center for maintenance.

INTRODUCTION

1.Basic System Architecture

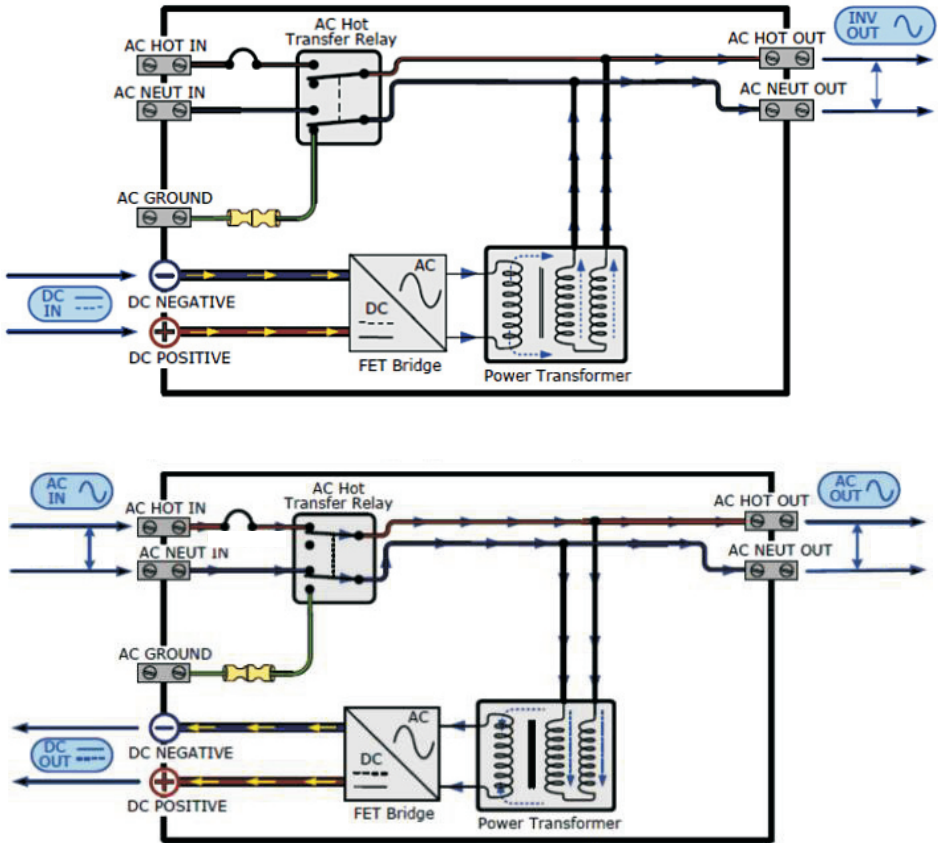

1.1 Instruction to working mode

Inversion priority mode

- (1) In case of normal battery voltage, the inverter operates under inversion mode and load power is supplied by battery inversion ;
- (2) the system automatically switches to battery-powered mode if the battery is fully charged by solar energy or wind Energy through controller.
- (3) the battery can also be charged when inverter operates under electric supply mode, which is determined by mode Setting of charging current. the charging current can be 0A if charging is unnecessary

Electric supply priority mode

(1) In case the load is powered by electric supply, the electric supply has to pass input protection device, And filter before supplying power to load in order to ensure power stability. it can be also charge the battery(determined By charging mode)

(2) in case of outage or abnormality of electric supply ,the system automatically switches to battery-powered mode

(3) in case electric supply is normal ,the system automatically switches to electric supply mode to supply power to load

2. Product Features

1. Pure sine wave inverter
2. Configurable input voltage range for home appliances and personal computers via LCD setting
3. Configurable battery charging current based on applications via LCD setting
4. LCD and LED Display
5. Over temperature auto restart
6. Overload/ Over temperature/ short circuit protection

PRODUCT OVERVIEW

1.Top view

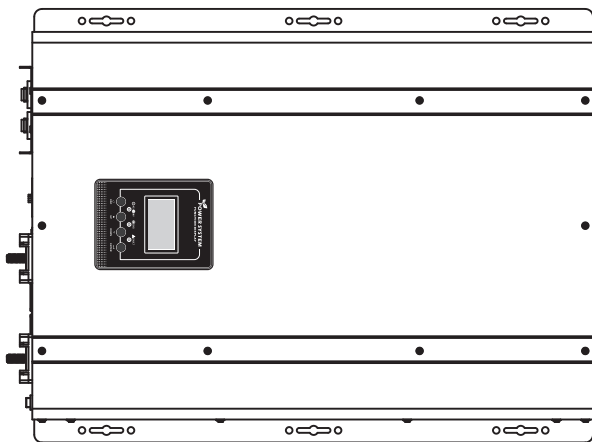

2.Real view

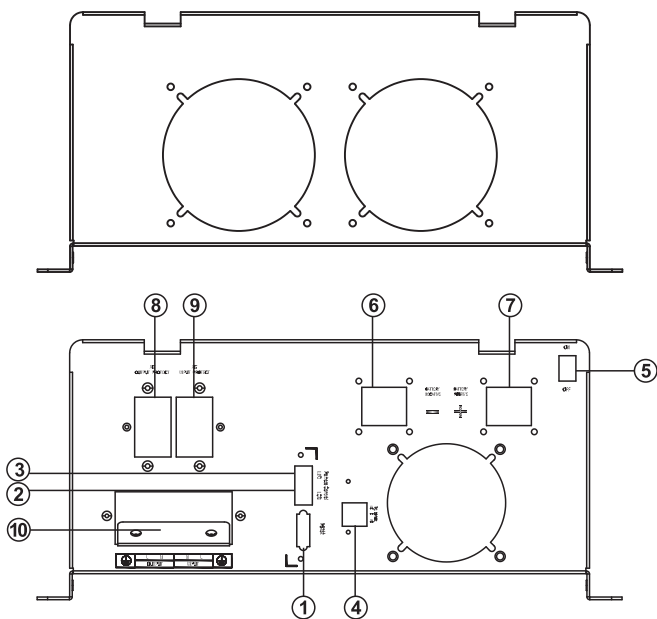

- 1. RS232 port
- 2. LCD remote control
- 3. LED remote control
- 4. Dry contact
- 5. On/Off
- 6. Battery negative

- 7. Battery positive
- 8. AC output protect
- 9. AC input protect
- 10. Output/Input

Operation and Display Panel

The operation and display panel, shown in below chart, is on the front panel of the inverter. It includes three indicators, four function keys and a LCD display, indicating the operating status and input/output power information.

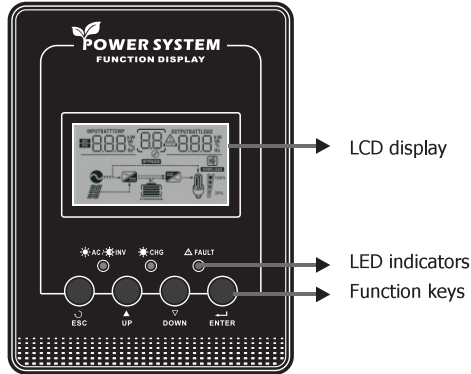

LED Indicator

| LED Indicator | | Messages | |
|----------------|-------|----------|---|
| ☀️ AC / ☀️ INV | Green | Solid On | Output is powered by utility in Line mode. |
| | | Flashing | Output is powered by battery or PV in battery mode. |
| ☀️ CHG | Green | Solid On | Battery is fully charged. |
| | | Flashing | Battery is charging. |
| ⚠️ FAULT | Red | Solid On | Fault occurs in the inverter. |
| | | Flashing | Warning condition occurs in the inverter. |

Function Keys

| Function Key | Description |
|--------------|--|
| ESC | To exit setting mode |
| UP | To go to previous selection |
| DOWN | To go to next selection |
| ENTER | To confirm the selection in setting mode or enter setting mode |

LCD Display Icons

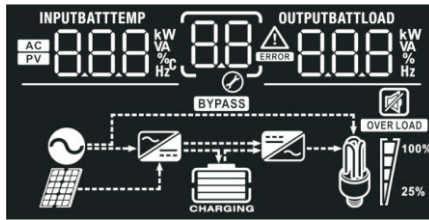

| Icon | Function description | |
|--|--|--|
| Input Source Information | | |
| | Indicates the AC input. | |
| | Indicates the PV input | |
| | Indicate input voltage, input frequency, PV voltage, battery voltage and charger current. | |
| Configuration Program and Fault Information | | |
| | Indicates the setting programs. | |
| | Indicates the warning and fault codes. | |
| Warning: | flashing with warning code. | |
| Fault: | lighting with fault code | |
| Output Information | | |
| | Indicate output voltage, output frequency, load percent, load in VA, load in Watt and discharging current. | |
| Battery Information | | |
| | Indicates battery level by 0-24%, 25-49%, 50-74% and 75-100% in battery mode and charging status in line mode. | |
| In AC mode, it will present battery charging status. | | |
| Status | Battery voltage | LCD Display |
| Constant Current mode / Constant Voltage mode | <2V/cell | 4 bars will flash in turns. |
| | 2 ~ 2.083V/cell | Bottom bar will be on and the other three bars will flash in turns. |
| | 2.083 ~ 2.167V/cell | Bottom two bars will be on and the other two bars will flash in turns. |
| | > 2.167 V/cell | Bottom three bars will be on and the top bar will flash. |
| Floating mode. Batteries are fully charged. | | 4 bars will be on. |

In battery mode, it will present battery capacity.

| Load Percentage | Battery Voltage | LCD Display |
|-----------------|--------------------------|-------------|
| Load >50% | < 1.717V/cell | |
| | 1.717V/cell ~ 1.8V/cell | |
| | 1.8 ~ 1.883V/cell | |
| | > 1.883 V/cell | |
| 50%> Load > 20% | < 1.817V/cell | |
| | 1.817V/cell ~ 1.9V/cell | |
| | 1.9 ~ 1.983V/cell | |
| | > 1.983 | |
| Load < 20% | < 1.867V/cell | |
| | 1.867V/cell ~ 1.95V/cell | |
| | 1.95 ~ 2.033V/cell | |
| | > 2.033 | |

Load Information

| | | | | |
|------------------|--|---------|---------|----------|
| OVER LOAD | Indicates overload. | | | |
| | Indicates the load level by 0-24%, 25-49%, 50-74% and 75-100%. | | | |
| | 0%-24% | 25%-49% | 50%-74% | 75%-100% |
| | | | | |

Mode Operation Information

| | |
|---------------|---|
| | Indicates unit connects to the mains. |
| | Indicates unit connects to the PV panel. |
| BYPASS | Indicates load is supplied by utility power. |
| | Indicates the utility charger circuit is working. |
| | Indicates the DC/AC inverter circuit is working. |

Mute Operation

| | |
|--|-----------------------------------|
| | Indicates unit alarm is disabled. |
|--|-----------------------------------|

LCD Setting









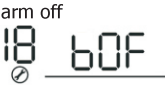

After pressing and holding ENTER button for 3 seconds, the unit will enter setting mode. Press "UP" or "DOWN" button to select setting programs. And then, press "ENTER" button to confirm the selection or ESC button to exit.

After setting out the output frequency, the output voltage, the charge current and the AC input voltage range, it is necessary to turn off the electricity and restart the inverter.

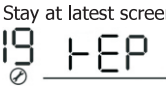
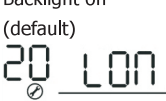

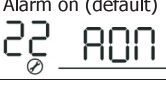

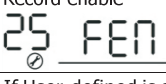
Setting Programs:

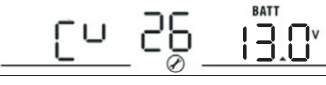
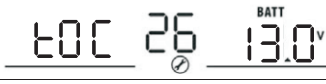
| Program | Description | Selectable option | | |
|---------|--|--|--|-----------|
| 00 | Exit setting mode | Escape 00 ESC | | |
| 01 | Output source priority: To configure load power source priority | Utility first (default) | Utility will provide power to the loads as first priority. battery energy will provide power to the loads only when utility power is not available. | |
| | | Battery priority | battery energy provides power to the loads as first priority. Utility provides power to the loads only when battery voltage drops to either low-level warning voltage or the setting point in program 12. | |
| 03 | Input voltage range | Wide Utility effective range: Nominal output voltage: -23%to+15% | 03 APL | |
| | | Narrow(default) Utility effective range: Nominal output voltage:-15%to+15% | 03 UPS | |
| 04 | Power saving mode enable/disable | Saving mode disable (default) | If disabled, no matter connected load is low or high, the on/off status of inverter output will not be effected. | |
| | | Saving mode enable | If enabled, the output of inverter will be off when connected load is pretty low or not detected. | |
| 05 | Battery type | Type of battery | Fast V | Floting V |
| | | Gel U.S.A | 14.0 | 13.7 |
| | | A.G.M.1 | 14.1 | 13.4 |











| | | | | |
|----|--|--|---|------|
| | | A.G.M.2 05 <u>b-3</u> ⊗ | 14.6 | 13.7 |
| | | Sealed lead acid 05 <u>b-4</u> ⊗ | 14.4 | 13.6 |
| | | Gel euro 05 <u>b-5</u> ⊗ | 14.4 | 13.8 |
| | | Open lead acid 05 <u>b-6</u> ⊗ | 14.8 | 13.8 |
| | | Calcium 05 <u>b-7</u> ⊗ | 15.1 | 13.6 |
| | | De-sulphation 05 <u>b-8</u> ⊗ | 15.5 for 4 hrs | |
| | | Li 05 <u>b-L</u> ⊗ | When the battery voltage reached to 14.7V, UPS closes the charge. UPS open charging when the battery voltage down to 12.5V. | |
| | | User-defined (default fast V 14.3, Floating V 13.7) 05 <u>b-0</u> ⊗ | If User-Defined is selected ,user can set the battery type in program 94 | |
| 07 | Auto restart when over temperature occurs | Restart disable (default) 07 <u>Ltd</u> ⊗ | Restart enable 07 <u>LtE</u> ⊗ | |
| 09 | Output frequency | 50Hz (default) 09 <u>50</u> Hz ⊗ | 60Hz 09 <u>60</u> Hz ⊗ | |
| 11 | Maximum utility charging current | Refer to Appendix ,the default is the maximum value , with 5A base, it can be up/down set, the minimum is 0A, the maximum can not exceed(Pout*0.42/VDC) 11 <u>5A</u> ⊗ | | |
| 12 | Low battery voltage inverter transfer to Utility | The default is low battery voltage alarm point setting range is from 10.5Vto 12.5Vfor 12V (*2for 24V, *4for 48V, *8for 96V),if the voltage set by user is below default point ,the default is low battery voltage alarm point. Increment of each click is 0.1V for 12V (*2for 24V, *4for 48V, *8for 96V) 12 <u>11.5</u> ^{BATT} ⊗ | | |







| | | | |
|----|---|---|---|
| 13 | High battery voltage recovery | Output of Battery model if battery voltage is set higher 13.5v-15.5v, otherwise it is output of bypass setting range is from 13.0Vto 15.5Vfor 12V (*2for 24V, *4for 48V, *8for 96V),if the voltage set by user Increment of each click is 0.2V for 12V (*2for 24V,*4for 48V, *8for 96V) | |
| | |  | |
| 18 | Alarm control | Alarm on (default)  | Alarm off  |
| 19 | Auto return to default display screen | Return to default display screen (default)  | If selected, no matter how users switch display screen, it will automatically return to default display screen (Input voltage /output voltage) after no button is pressed for 1 minute. |
| | | Stay at latest screen  | If selected, the display screen will stay at latest screen user finally switches. |
| 20 | Backlight control | Backlight on (default)  | Backlight off  |
| 22 | Beeps while primary source is interrupted | Alarm on (default)  | Alarm off  |
| 25 | Record Fault code | Record enable  | Record disable (default)  |
| 26 | Bulk charging voltage(C.V voltage) | If User-defined is selected in program94,this program can be set up.setting range is from 13.0V to 15.5V for 12V (*2for 24V, *4 for 48V,*8for 96V) | |
| | Maximum charging voltage for lithium battery,when the battery voltage reached the charge voltage,it closes the charge | If User-defined is selected in program 94,this program can be set the maximum charging voltage.setting range is from 13.0V-15.5V | |
| | |  | |
| | |  | |

| | | | |
|----|---|--|--|
| 27 | Floating charging voltage | If User-defined is selected in program 94, this program can be set up. setting range is from 13.0V to 15.0V for 12V(2* for 24V, *4for 48V, *8for 96V) | |
| | Battery low voltage open charging (for lithium battery) | If User-defined is selected in program 94, this program can be set up. setting range is from 12.0V to 14.0V for 12V(2*for 24V, *4for 48V, *8for 96V) | |
| 29 | Low DC cut-off voltage | The default single section is 10.0V .setting range is from 10.0Vto 12Vfor 12V (*2for 24V, *4for 48V, *8for 96V)) Increment of each click is 0.1V for 12V (*2for 24V, *4for 48V, *8for 96V) | |
| 93 | Frequency Range | Special 40-70HZ | |
| | | General 50HZ 45-55HZ/ 60HZ 55-65HZ | |
| 94 | Selection of battery type | Lithium battery | If selected, battery charge voltage and battery low open charging can be set up in program 26,27 |
| | | Other battery | If selected ,battery charge voltage can be set up in program 26,27 |
| 95 | Battery high voltage trip | When dry contact switch from NC to NO, battery voltage arrive to setting voltage, dry contact point switch to NC. This setting can not be higher than fast charge voltage. setting range is from 13.0V to 15.5V for 12V (*2for 24V, *4for 48V, *8for 96V) Increment of each click is 0.1V for 12V (*2for 24V, *4for 48V, *8for 96V) | |

| | | |
|----|--------------------------|---|
| 96 | Battery low voltage trip | <p>When battery voltage arrive to setting point, the dry contact switch from NC to NO. This setting can not be lower than low battery voltage cut off point. setting range is from 10.5V to 12.5Vfor 12V (*2for 24V,*4for 48V,*8for 96V) Increment of each click is 0.1V for 12V (*2for 24V,*4for 48V,*8for 96V)</p>  |
| 97 | Dry contact control | <p>If inverter is set in dcd, dry contact function is disable, 95,96 can not be set up in program.</p>  |
| | | <p>If inverter is set in dce, dry contact function is enable and 95,96 can be set up in program.</p>  |
| 98 | Low battery alarm | <p>The default is 10.5V The setting range is 10.5-12.5V for12V (*2for 24V,*4for 48V,*8for 96V).if the shutdown voltage set by the user is lower than the default voltage point ,the default will be low voltage shutdown point +0.5V Increment of each click is 0.1V for 12V (*2for 24V,*4 for 48V,*8for 96V)</p>  |
| 99 | Output voltage setting | <p>The default is 230V/120V setting range is from 200V/100Vto 240V/120V Increment of each click is 5V for 120V machine Increment of each click is 10V for 230V machine</p>  |

Fault Reference Code

| warning code | warning event | Icon on |
|--------------|--|---|
| 03 | Battery voltage overcharge |  |
| 04 | Battery voltage is too low |  |
| 05 | Inverter over temperature |  |
| 07 | Inverter over load |  |
| 12 | PV input voltage is too low |  |
| 13 | PV input voltage is too higher |  |
| 14 | PV over current |  |
| 15 | PV over temperature |  |
| 88 | Transformer phase reversal |  |
| 89 | Frequency is out of range |  |
| 97 | Inverter fail to communicate with MPPT |  |

| Fault Code | Fault Event | Icon on |
|------------|-------------------------------|---|
| 02 | Heat sink over temperature |  |
| 03 | Battery voltage is too higher |  |
| 04 | Battery voltage is too low |  |
| 05 | Output short circuit |  |
| 06 | Output is too high or too low |  |
| 07 | Overload |  |
| 99 | Inverter fail to slow start |  |

SPECIFICATIONS

| MODEL | | 8048E | 8096E | 10048E | 10096E | 12048E | 12096E | |
|--------------------|--|--|-------|--------|-----------------------------------|--------|--------|--|
| Rated Output Power | | 8000W | | 10000W | | 12000W | | |
| Transfer Time | | 10ms typical | | | | | | |
| Invert mode | Nominal output voltage rms | 230VAC(200~240VAC 10V Gear setting) | | | | | | |
| | Output frequency | 50HZ±0.3HZ or 60HZ±0.3HZ | | | | | | |
| | Output wave form | Pure Sine wave | | | | | | |
| | Output overload | 105% > Load < 120% ±10%: Fault (turn off output after 10 seconds) 120% > Load < 150% ±10%: Fault (turn off output after 3 seconds) 150% > Load ±10%: Fault (turn off output after 1 seconds) | | | | | | |
| | Short circuit protection | Software protection | | | | | | |
| | Nominal efficiency | >88% | | | | | | |
| | Power factor | 0.9-1 | | | | | | |
| Line mode | Input voltage range | Narrow range | | | Wide range | | | |
| | | Nominal output voltage±15% | | | Nominal output voltage +15%, -23% | | | |
| | Input frequency voltage | 40Hz-70Hz | | | | | | |
| | Input wave form | Sine wave(Utility or generator) | | | | | | |
| | Short circuit protection | Circuit breaker | | | | | | |
| | Output Overload | 120% > Load < 150% ±10%: fault (turn off output after 60 seconds); 150% > Load ±10%: fault (turn off output after 1 seconds) | | | | | | |
| | Over Charge protection shutdown | 16.0for12Vdc/*2for24V/*4for48V/*8for 96V | | | | | | |
| | Efficiency online transfer mode | >95% | | | | | | |
| | AC Charge | Charge current can be set (5A UP/DOWN setting, For specific parameters, please refer to Appendix) | | | | | | |
| | Selection of battery charging Voltage type | | | | | | | |
| | Battery type | Fast V | | | Float V | | | |
| | Gel U.S.A | 14.0 | | | 13.7 | | | |
| | A.G.M 1 | 14.1 | | | 13.4 | | | |
| | A.G.M 2 | 14.6 | | | 13.7 | | | |
| Sealed Lead Acid | 14.4 | | | 13.6 | | | | |
| Gel Euro | 14.4 | | | 13.8 | | | | |
| Open Lead Acid | 14.8 | | | 13.3 | | | | |
| Calcium | 15.1 | | | 13.6 | | | | |
| De sulphation | 15,5 for 4 hrs then off | | | | | | | |
| Li | 14.7 | | | | | | | |
| other | User-defined | | | | | | | |

| | | | | |
|---------|-----------------------------|--|---------|---------|
| Battery | Nominal DC Input Voltage | 48V/96V | 48V/96V | 48V/96V |
| | Battery voltage range | 12V(10Vdc ~16Vdc) ±0.3Vdc /*2for24V/*4for48V/*8for 96V | | |
| | Low DC Warning Voltage | 12V(10.5Vdc ±0.3Vdc)/*2for24V/*4for48V/*8for 96V | | |
| | Low DC Cut-off Voltage | 12V(10Vdc±0.3Vdc)/*2for24V/*4for48V/*8for 96V | | |
| others | Operating Temperature Range | 0~40℃ | | |
| | Humidity | 0%~95% | | |
| | Noise | <50dB | | |
| | Dimension (D*W*H), mm | 584*450*200 | | |

Appendix

| Model | Power value | Charge current |
|--------|-------------|----------------|
| 8048E | 8000W | 70A |
| 8096E | | 35A |
| 10048E | 10000W | 75A |
| 10096E | | 40A |
| 12048E | 12000W | 75A |
| 12096E | | 50A |

*Product specifications are subject to change without further notice